

ThermoFlexX 60



The ThermoFlexX 60 with its maximum plate size of 1067 x 1524 mm (42 x 60") is the perfect fit for the medium and wide web segment. It's an excellent choice for ambitious printers and trade shops to make plates in the shortest time possible at highest quality. ThermoFlexX 60 is an ideal size to handle larger plates or making large amounts of jobs together, reducing material waste to a minimum. ThermoFlexX 60 is the ultimate flexo plate imager combining superior quality, handling and productivity.

High quality imaging

- + The new generation optical system offers superior quality thanks to a unique design using leading edge technology. The fiber laser represents today's best technology for digital imaging, offering superior quality. The robustly designed ThermoFlexX is made using heavy duty industrial components, making high speeds possible without fluctuation and vibrations. This provides the most accurate and consistent imaging quality available today.

Ease of Use

- + The ThermoFlexX 60 can automatically load and unload plates with one touch of a button. Manual plate handling is one of the main causes of plate damage. With this in mind we designed the FlexTray. This mobile table, which can be adjusted in height and tilted, facilitates very easy plate handling and transport.

Low Plate Waste

- + Clever technical innovation, such as the unique vacuum slider, demonstrate our understanding that users need to save cost and time. No more taping partial plates!

Open

- + ThermoFlexX imagers excel in their choice of resolution. Any of the industry standards can be used. ThermoFlexX imagers can be integrated with any workflow or RIP that can produce 1-bit TIFF file format. Closed file formats such as LEN-files can be seamlessly converted to 1-bit TIFF. ThermoFlexX can image all digital plates, any brand, solvent, water washable or thermal processing, and is compatible with all plate making equipment.

Productivity

- + The new imaging system is not only built for optimum quality, but also to combine this quality with superior speeds. Productivity up to 6m²/h can be achieved at the standard quality of 2540dpi. This can be doubled up to 12m², thanks to our Dual Head Imaging concept. This concept also offers a certain level of redundancy.



ThermoFlexX 60

Motion Accuracy

- + The robust design is based on a modular platform with a small footprint. The imaging system is driven by linear motors with ultimate accuracy. The direct drum drive guarantees a continuous speed without fluctuations.



Laser Protection Plate

- + A plate flying off because of loading errors can happen on any CTP. These accidents can seriously damage the imaging unit leaving it out of operation for days as a consequence. A protection plate, installed on a separate rail system intercepts impact from a plate at any time.

Imaging Software

- + The ThermoFlexX imager is controlled by a 360° rotating display. This makes the machine accessible from any side. The intuitive interface shows the job list with all parameters and a preview of the currently imaging plate. The imaging progress on the plate preview screen is clearly visible all around the plate room.



Auto Loading

- + The ThermoFlexX 60 can automatically load and unload plates with one touch of a button. An innovative guidance system makes sure that even thick plates, up to 6,35 mm (0.25"), can be seamlessly mounted on the drum, all automatically.



Flextray

- + Manual plate handling is one of the main causes of plate damage. With this in mind we designed the Flextray. This mobile table, which can be adjusted in height and tilted, facilitates very easy plate handling and transport.



Automatic Calibration

- + The new generation optical system offers superior quality thanks to a unique design using leading edge technology. Our standard auto-calibration system guarantees consistency and high quality imaging.

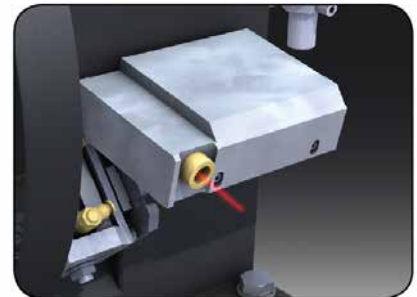

ThermoFlexX 60

3 Component Imaging Head

- + The imaging system consists of 3 independent modules: motor, optics and laser. This flexible design allows straight-forward replacement of any of the modules. It is even possible to perform optical fine tuning remotely. This makes service interventions simple and hardware upgrades effortless and straightforward.

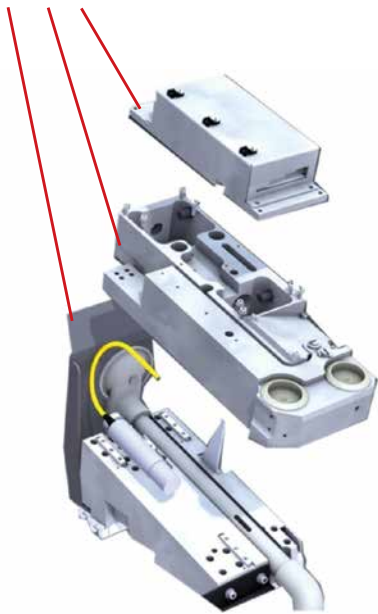

Innovative Screening

- + ThermoFlexX screening technology offers superb high-lights with a smooth transition to 0% tint value, while solids and line-work retain excellent detail.

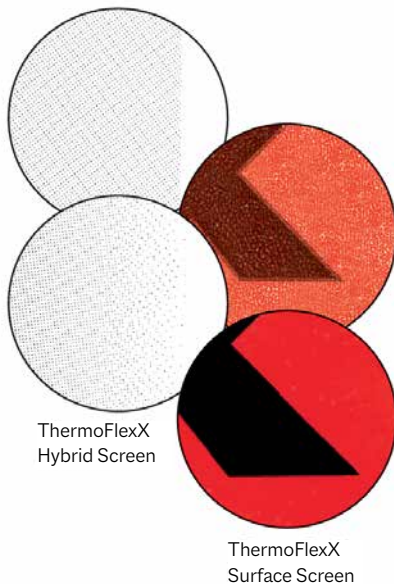

Multi Resolution

- + ThermoFlexX supports all 1-bit TIFF formats from any RIP at all standard resolutions 2000, 2400, 2540, 4000, 4800, 5080 dpi. Closed file formats such as LEN files can be converted seamlessly to 1-bit TIFF format. In the Multiplate software, TIFF's with different resolution can be combined on one plate.

Multi Plate

- + MultiPlate is an intuitive interface providing amazing ease of use. 1-bit TIFF's are arranged automatically or manually and jobs of different resolutions can be combined. The status of different jobs is clearly presented. With the search and filter tool you can easily find files, even if they are stored in an archive.

High Resolution

- + With 5080 dpi resolution, we push quality standards to a higher level.
 - + smaller screen dots & finer details
 - + sharper text and line-work
 - + full image contrast
 - + greater production stability through platemaking and printing

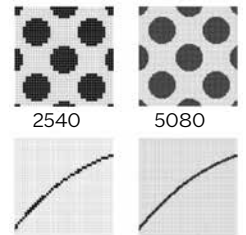

Automatic Vacuum Slider

- + Optimum plate handling and manipulation avoids accidental damage. The automatic vacuum slider, a unique feature on ThermoFlexX imagers, offers efficient operation for partial plates. By moving the slider to the edge of the plate the vacuum is concentrated beneath the plate, which eliminates the need for taping and foil covering but still allows full speed imaging.



Automatic Resolution Switching

- + The optical system is based on multiple lenses. We use the most suitable lens for each resolution without compromise in quality. Changing resolution is performed automatically in the background. The possibility of combining jobs with different resolutions on one plate saves time and avoids imposition mistakes.

ThermoFlexX 60

Technical characteristics	ThermoFlexX 60 E	ThermoFlexX 60 S	ThermoFlexX 60 D
Laser type	Fiber laser 1064nm		
Laser power	50 W	100 W*	2 x 100 W*
Standard resolution ¹	2400 2540	2400 2540	2400 2540
High resolution ¹	4000* 4800* 5080*	4000* 4800* 5080*	4000* 4800* 5080*
Productivity 2400dpi ²	3	6*	12*
Productivity 5080dpi ²	1.5	3*	6*
Image quality	at 2540 dpi: up to 175lpi / at 5080 dpi: up to 250lpi		
Loading table	FlexTray		
Hybrid Drum option			
Customized register pins	No		
Customized magnetic zones			
Clamping system	Automatic		
Resolution change	Automatic		
Focus setting	Auto focus		
Plate loading	Manual / Automatic		
Partial Plate handling	Automatic Vacuum Slider		
Maximum Plate sizes (drum dimensions)	1067 x 1524mm or 42" x 60" (width: 1524 mm / circumference: 1067 mm)		
Plate thickness	0.73 to 6.35mm 0.029 to 0.25"		
Mountable plate materials	Flexo plates and letterpress plates on polyester base Dry Films 0,2mm Digital Screens Gallus Screeny Metal back plates Not possible		
Applications	Corrugated Packaging Folding Carton Flexible Packaging		
Top & Bottom clamp space	15mm / 0.6"		
Machine dimensions	Width: 3130mm / 120" ¹ Depth: 1223 / 48.2" Height: 1200mm / 47.3"		
Required Floor Space	5100 x 5500 mm 200"x 216"		
Weight	3500 kg / 7716 lb		
Compressed Air	Min. 6 bar - free of oil/condensation Compressor not included- 0.5" connection		
Electrical connection	Voltage: 3x400 V (+/-5%) N, PE Frequency: 50 Hz- 60 Hz Fuse: 20A		
Exhaust & Filter system	External exhaust carbon filter system with carbon filter		
Vacuum system	External vacuum system provided		
Operating conditions	Humidity, max 70% Temperature 15-26° / 59-79 F / (+/-2%)		
Multiplate Software Platform Specification	Windows 10 Professional Server 64 bit 3 Ghz Quad Core (4 cores with Hyperthreading) 32 GB RAM DVD ROM/ Minimum 1 USB port for Dongle Dual 100/1000 Network Interface 1 TB hard disk		

Front view

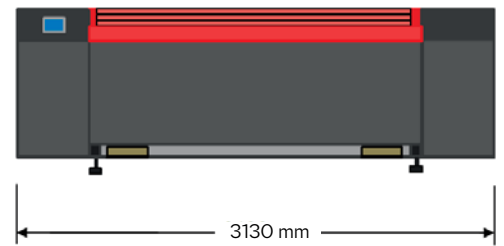

Side view

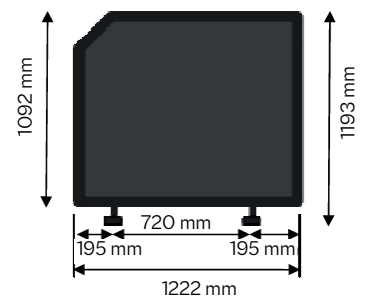

Floor plan

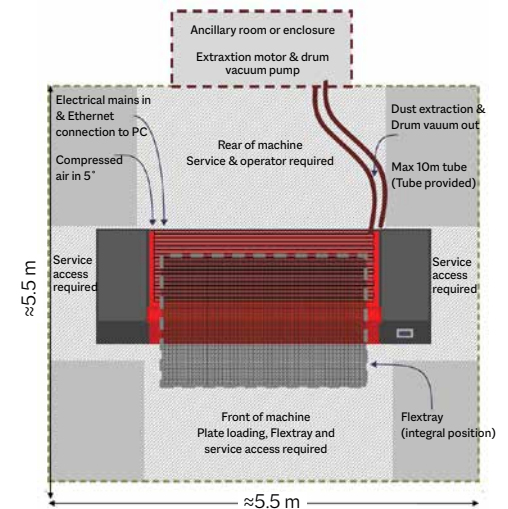

Flextray

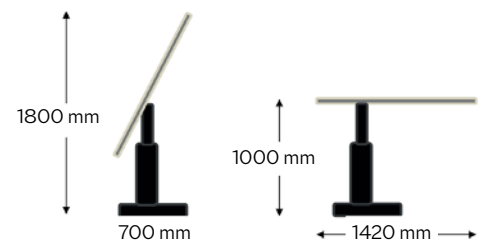

1) By default one resolution (2400 or 2540dpi) comes with the imager. Additional resolutions are optional.
2) Depending on plate type and quality requirements. Thicker plates are imaged 60% of the mentioned productivity. * Optional

Please contact us for additional information.
info@xsysglobal.com • www.xsysglobal.com

The aim of our technical documents is to inform and advise our customers. The information provided herein is correct to the best of XSYS's knowledge. No liability for any errors, facts or opinions is accepted. Customers must satisfy themselves as to the suitability of this product for their application. No responsibility for any loss as a result of any person placing reliance on any material contained herein will be accepted. Product names followed by ® are trademarks registered by XSYS Germany GmbH and/or its affiliates.



Print solid. Stay flexible.

02-2021